

## Lithium Ion Battery

Discover Advanced Energy (AES) allow for equipment design and functionality improvements and deliver productivity gains through enhanced cycling, charge time and weight reductions in stationary and mobile applications. Dramatic improvements in cycle life and charge efficiency combined with zero maintenance requirements provide the end user with significant cost of ownership savings.

### MECHANICAL DRAWINGS

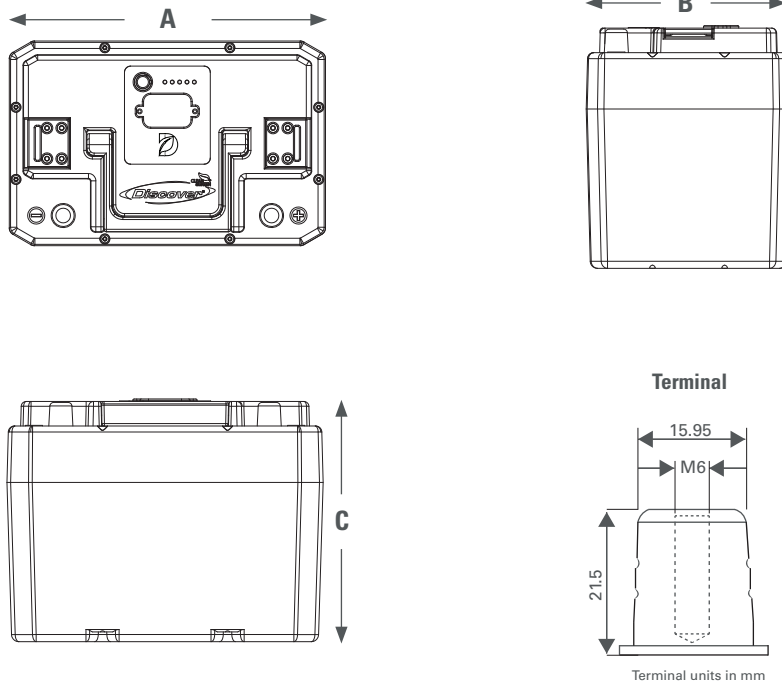

### MECHANICAL SPECIFICATIONS

Length (A)	258 mm	10.2 in
Width (B)	167 mm	6.6 in
Height (C)	198 mm	7.8 in
Weight	12.4 kg	27.3 lb
Terminal	A2-M6	
Terminal Torque	7.0 - 7.7 Nm	5.1 - 5.7 ft-lb
Case Material	PC-ABS UL 94 V0 Compliant	
IP Rating	IP 55	

### ELECTRICAL SPECIFICATIONS

Cell Chemistry	LiFePO <sub>4</sub>	
Cell Modules	12S 5P	
Charge Temperature	0°C / 45°C	32°F / 113°F
Discharge Temperature	-20°C / 50°C	-4°F / 122°F
Storage Temperature	-20°C / 45°C	-4°F / 113°F
Self-Discharge 25°C / 77°F	3% per month (battery off)	

CAUTION: Extra considerations must be given to depths of discharge, operating voltages and currents when designing systems for use at maximum temperatures.

### ELECTRICAL SPECIFICATIONS

Nominal Voltage	38.4 V
Charge Voltage	40.8 V
Maximum Voltage*	44.4 V
Minimum Voltage	33.6 V
Nominal Capacity (1C)**	25 Ah
Nominal Energy (1C)**	960 Wh
Max Continuous Current	25 A
Peak Current	< 200 A for 5 s

Electrical Specifications at 25°C.  
\* Do not exceed 60V at the battery terminals.

Constant Power - Minutes of Discharge			
300 W	500 W	800 W	1000 W
205	123	77	61
Constant Current - Minutes of Discharge			
@5A	@10A	@25A	@40A
240	120	48	30

### BENEFITS & FEATURES

#### Efficient & Fast Charging

Discover AES batteries are 15% more efficient than lead acid batteries, allowing for reduced charge times and greater productivity.

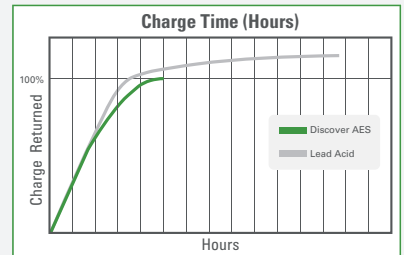

#### Efficient and Stable Discharge

Deliver > 95% of their capacity at high and stable voltages, increasing equipment performance and reducing motor fatigue.

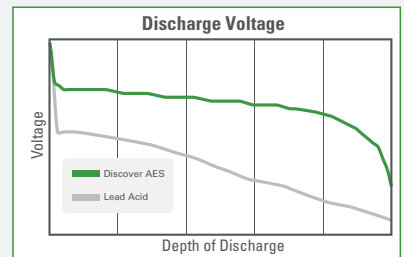

#### Partial State of Charge (SOC)

Discover AES batteries will not suffer negative effects from partial SOC.

#### Weight Efficient

Systems are 1/3 the weight of their lead acid battery equivalent.

#### Battery Management System

Integrated Battery Management System to prevent abuse outside of current, voltage and temperature limits.

### SAFETY AND PERFORMANCE CERTIFIED

- IEC 62133 (pending)
- UL 2271 (pending)
- UN 38.3

### SHIPPING CLASSIFICATION

- UN 3480, Class 9 (Lithium ion batteries)

**UN38.3 PASSED**  
TRANSPORT SAFETY CERTIFIED



Do not mix with lead acid batteries when recycling.

**NOTE 1:**

Qualification is a hand shaking procedure that allows a charger to wake up an auto-on equipped AES battery. Qualification is an optional feature and not required for standard charging.

**CAUTION:**

Extra considerations must be given to depths of discharge, operating voltages and currents when designing systems for use at maximum operating temperatures.

**VOLTAGE REGULATED IU CURVE <sup>Δ</sup>**

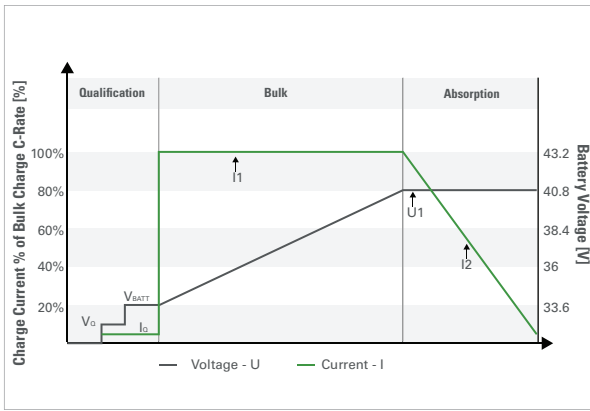

**VOLTAGE REGULATED IU CHARGING CURVE PARAMETERS**

Nominal Voltage	36 V
Qualification Voltage ( $V_0^*$ )	Min 12 V / Max 36 V ( $I_0 < 1$ A)
Battery Voltage ( $V_{BATT}$ )	$\geq 30$ V
Bulk Current (I1)	13 A recommended 25 A maximum
Absorption Voltage (U1)	40.8 V
Termination Charge Current	$I_2 \leq 2$ A

\*Qualification is optional to utilize auto-on feature

**VOLTAGE IN RELATION TO THE STATE OF CHARGE (SOC)**

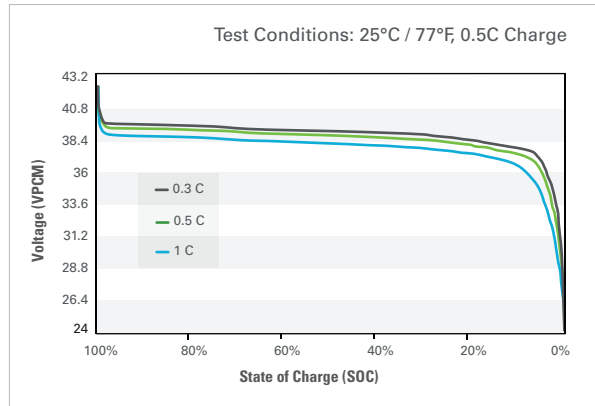

**DISCHARGE VOLTAGE IN RELATION TO THE TEMPERATURE**

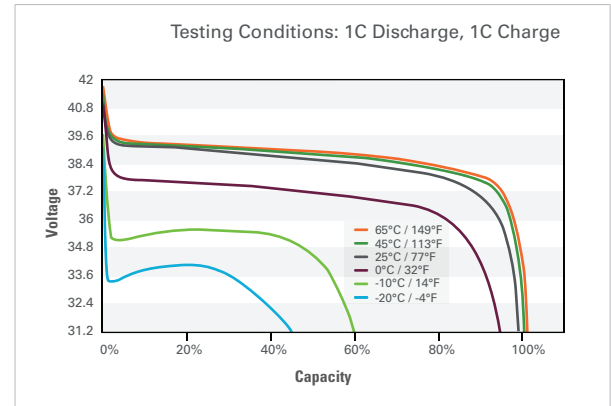

**THERMAL DERATING CURVE (CURRENT) <sup>◊</sup>**

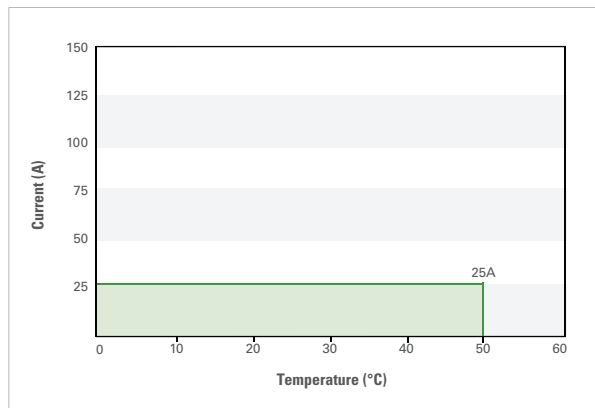

**CAUTION:**

Direct connection to DC motors without proper safety protection, motor controllers, and external motor voltage clamping systems (such as high power anti-parallel diodes or braking resistor systems) may result in damage to the internal pack protection system which may result in unsafe situations. Please consult Discover technical support before directly connecting any motor loads.

Discover Energy Corp. attempts to ensure the correctness of the product description and data contained herein. We reserve the right to change designs, specifications and pricing at any time without notice or obligation. It is the responsibility of the reader of this information to verify any and all information presented herein.